

Memorex[®]

14 CHANNEL FRS BASE STATION MODEL: MK1800

**BEFORE OPERATING THIS PRODUCT,
PLEASE READ THESE INSTRUCTIONS COMPLETELY.**

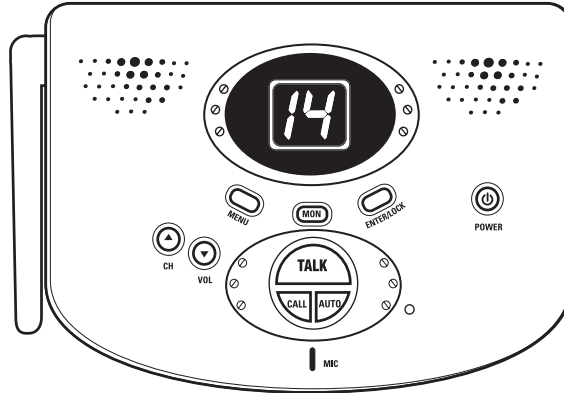

OPERATING INSTRUCTIONS

SAFETY PRECAUTIONS



CAUTION
RISK OF ELECTRIC SHOCK
DO NOT OPEN



CAUTION: TO REDUCE THE RISK OF ELECTRIC SHOCK, DO NOT REMOVE COVER (OR BACK). NO USER-SERVICEABLE PARTS INSIDE. REFER SERVICING TO QUALIFIED SERVICE PERSONNEL.



DANGEROUS VOLTAGE

The lightning flash with arrowhead symbol, within an equilateral triangle is intended to alert the user to the presence of uninsulated dangerous voltage within the product's enclosure that may be of sufficient magnitude to constitute a risk of electric shock to persons.



ATTENTION

The exclamation point within an equilateral triangle is intended to alert the user to the presence of important operating and maintenance (servicing) instructions in the literature accompanying the appliance.

SURGE PROTECTORS:

It is recommended to use a surge protector for AC connection. Lightning and power surges ARE NOT covered under warranty for this product.

IMPORTANT:

PLEASE KEEP ALL PACKAGING MATERIAL FOR AT LEAST 90 DAYS IN CASE YOU NEED TO RETURN THIS PRODUCT TO YOUR PLACE OF PURCHASE OR MEMOREX.

Before using, fill out and mail the registration card. This will make sure a permanent record is made with the date of purchase in case service is needed.

SAFETY PRECAUTIONS (CONTINUED)

FCC WARNINGS:

This device complies with part 15 of the FCC rules. Operation is subject to the condition that this device does not cause harmful interference.

PRECAUTIONS:

- Do not modify or attempt to adjust the transceiver for any reason.
- Avoid extremes in exposure to water, heat and cold.
- Do not expose the transceiver to long periods of direct sunlight, nor should the transceiver be placed close to heating appliances.
- Do not place the transceiver in excessively dusty areas, humid areas, wet areas, or on unstable surfaces.
- If smoke is coming from the transceiver, immediately turn off the power and remove the batteries or unplug the unit. Contact your dealer.

LOCATION OF CONTROLS

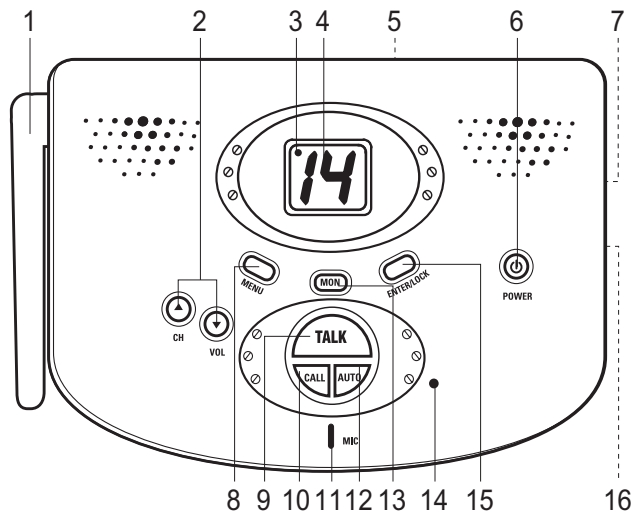

1. Antenna
2. CHANNEL/VOLUME Up/Down Buttons
3. Transmit Indicator
4. Display
5. Battery Compartment (Bottom of Unit)
6. POWER Button
7. MIC/EARPHONE Jack (Side of Unit)
8. MENU Button
9. TALK Button
10. CALL Button
11. MIC (Microphone)
12. AUTO Button
13. MONITOR Button
14. Power/VOX Indicator
15. ENTER/LOCK Button
16. DC6V Jack  (Side of Unit)

POWER SOURCES

BATTERY INSTALLATION

Open the battery compartment and insert four (4) "AA" size batteries (not included) following the polarity diagram. Put the battery compartment cover back into place. When the battery is low, the display will show "L" and blink.

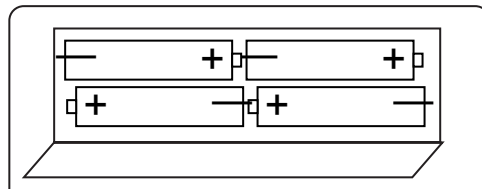

BATTERY PRECAUTIONS

Follow these precautions when using batteries in this device:

1. Use only the size and type of batteries specified.
2. Be sure to follow the correct polarity when installing the batteries as indicated in the battery compartment. Reversed batteries may cause damage to the device.
3. Do not mix different types of batteries together (e.g. Alkaline and Carbon-zinc) or old batteries with fresh ones.
4. If the device is not to be used for a long period of time, remove the batteries to prevent damage or injury from possible battery leakage.
5. Do not try to recharge batteries not intended to be recharged; they can overheat and rupture. (Follow battery manufacturer's directions.)

DC JACK

To use this unit with the provided AC adapter having 6V and a positive center pin, insert the AC adapter's plug into the DC6V jack on the unit and the other end into an AC outlet. The batteries will be disconnected when the AC adapter is connected.

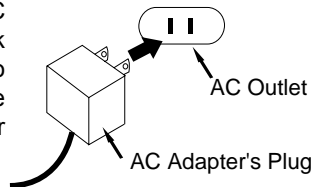

OPERATION

TO TURN THE UNIT ON/OFF ANTENNA

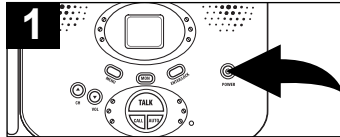

ON: Press and hold the POWER button for 1 second; the unit will beep and the Power/VOX indicator will light green.

OFF: Press and hold the POWER button for 1 second; the unit will beep and the Power/VOX indicator will turn off.

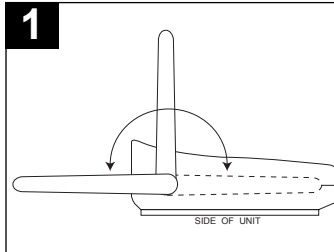

For best results, rotate the antenna angle to 90° to 180° as shown in the figure above.

If there are no transmissions for 2 seconds, the unit will automatically switch to standby mode (display will turn off), which will save batteries (if used). When a transmission is received or if you attempt to send a transmission, the display will turn back on.

TO ADJUST THE VOLUME

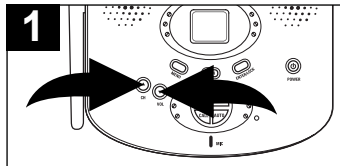

To adjust the volume, press the CHANNEL/VOLUME Up or Down button until the desired level (1 to 16) appears in the display.

TO SELECT A CHANNEL

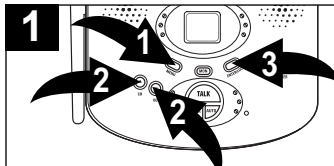

To select a channel, press the MENU button ① once and the display will blink. Within 7 seconds, press the CHANNEL/ VOLUME Up or Down button ② until the desired channel (1 to 14) appears in the display. Press the ENTER/LOCK button ③ when done.

OPERATION (CONTINUED)

TO SET THE BEEP

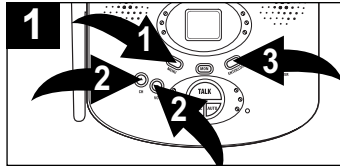

This option will determine whether or not a beep is heard after each button press. Press the MENU button ❶ twice and the display will either show "b" or "-". Within 7 seconds, press the CHANNEL/VOLUME Up or Down button ❷ to turn the beep on ("b" will appear in the display), or off ("- will appear). Press the ENTER/LOCK button ❸ when done.

TO TRANSMIT

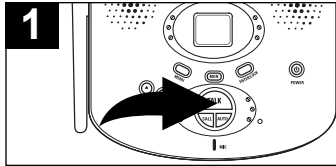

To transmit, press and hold the TALK button and speak into the built-in microphone (or the external microphone, if connected). When the TALK button is pressed, the Transmit indicator will light and the speaker will be muted. When the TALK button is released, the listener will hear a beep to confirm you are done speaking.

TO MONITOR

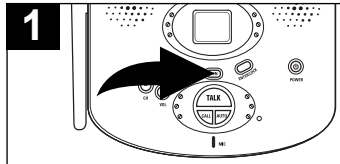

This function will unmute the speaker/disable Auto Squelch as long as it is pressed. This is useful to hear signals that are too weak to be recognized or to adjust the volume to background noise. To monitor, simply press and hold the MONITOR button.

TO SEND A CALL TONE

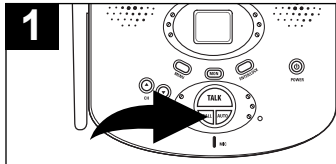

This function will send a distinctive tone to users who are tuned to the same channel as your unit. The users you are trying to reach will recognize your distinctive call tone. To send a call tone, simply press the CALL button once.

OPERATION (CONTINUED)

LISTENING TO TRANSMISSIONS TO LOCK CONTROL KEYS

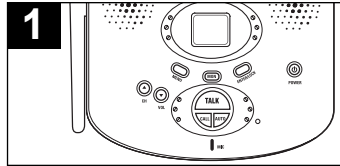

When the unit is on, it will automatically broadcast the incoming signal when a strong incoming signal is received on the selected channel.

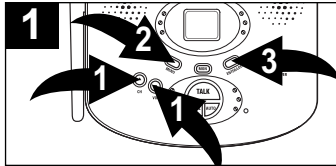

This function will lock the CHANNEL/VOLUME Up/Down ❶ and the MENU ❷ buttons.
 To activate, press and hold the ENTER/LOCK button ❸ for 2 seconds; the unit will beep and “L” will briefly appear in the display.
 To deactivate, press and hold the ENTER/LOCK button ❸ for 2 seconds; the unit will beep and “-” will briefly appear in the display.

AUTO SQUELCH

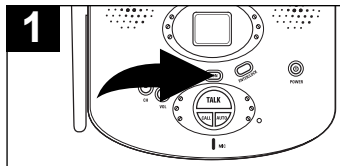

This unit is equipped with Auto Squelch, which will automatically mute weak transmissions and unwanted noise. Auto Squelch can be temporarily turned off using the MONITOR button (see TO MONITOR section on the previous page.)

VOX (VOICE ACTIVATION)

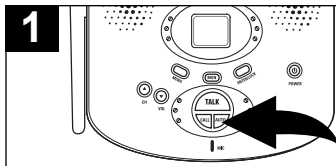

Voice activation will allow you to listen/transmit while freeing your hands for other tasks. Press the AUTO button; the Power/VOX indicator will light red. Then whenever the unit detects a sound or voice, it will automatically transmit. To shut this function off, press the AUTO button again; the Power/VOX indicator will light green.

OPERATION (CONTINUED)

CONNECTING EARPHONE/HEADPHONES:

For private listening, you can connect an earphone or headphones with a 1/8-inch plug to the MIC/EARPHONE jack on the side of the unit. This automatically disconnects the internal speaker. Adjust to a desired volume level, but do not adjust the volume too high to avoid damage to your hearing.

CONNECTING A MICROPHONE:

Connect a microphone with a 1/8-inch plug to the MIC/EARPHONE jack on the side of the unit. This automatically disconnects the internal microphone.

FREQUENCY RANGE:

FRS CHANNEL	CHANNEL FREQUENCY (MHZ)
1	462.5625
2	462.5875
3	462.6125
4	462.6375
5	462.6625
6	462.6875
7	462.7125
8	467.5625
9	467.5875
10	467.6125
11	467.6375
12	467.6625
13	467.6875
14	467.7125

SPECIFICATIONS

FREQUENCY:

Frequency 462 ~ 467 MHz

RECEIVER:

Sensitivity (12 db signal) 0.25 uV
Max audio output @10THD 300 mW
Max S/N ratio @ 1mV RF input 40 dB
Squelch sensitivity 0.2 uV
Audio frequency response (300Hz/3000Hz) ± 10 dB
Signal displacement BW ± 5 Hz
Adjacent channel rejection 50 dB
Intermodulation rejection 50 dB
Spurious response rejection 50 dB

TRANSMITTER:

Effective radiated power 300 mW
Carrier frequency stability ± 1 KHz
Modulation limiting 2.5 KHz
Carrier attack time 80 mS
Audio frequency response (300Hz/3000Hz) ± 10 dB
Audio distortion 3%
Hum and noise 30 dB

POWER SUPPLY

Battery life (1:1:8 Ratio). 30 hrs
Batteries (4 X 1.5V "AA" 4.8 – 6.0V

Specifications are subject to change without notice.

FOR ADDITIONAL SET-UP OR OPERATING ASSISTANCE,
PLEASE VISIT OUR WEBSITE AT

WWW.MEMCORPINC.COM

OR CONTACT CUSTOMER SERVICE AT 1-800-919-3647

PLEASE KEEP ALL PACKAGING MATERIAL FOR AT
LEAST 90 DAYS IN CASE YOU NEED TO RETURN THIS
PRODUCT TO YOUR PLACE OF PURCHASE OR
MEMOREX.

FOR PARTS AND ACCESSORIES, CONTACT FOX INT'L
AT 1-800-321-6993.

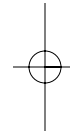
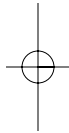

Memcorp, Inc.
Weston, FL
Printed in Hong Kong

Visit our website at www.memcorpinc.com

